

THANK YOU FOR CHOOSING YARDCORE

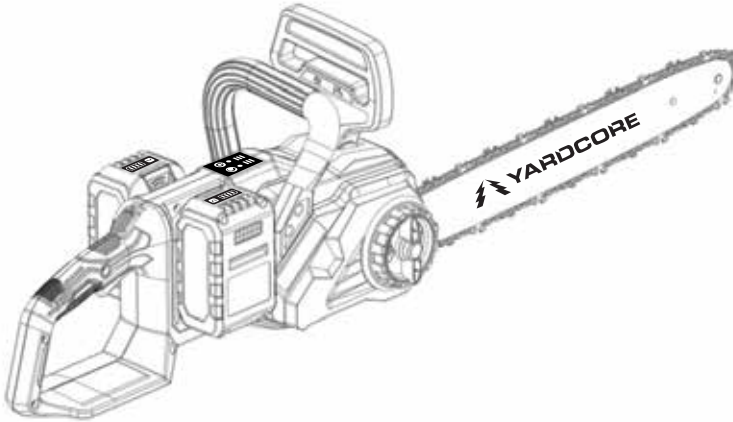

YARDCORE®
TOOLS BUILT FOR NATURE

INSTRUCTION MANUAL CORDLESS CHAINSAW



40 VOLT LITHIUM ION 16"

TOOL MODEL NUMBER YC-CS4016



THIS TOOL IS AVAILABLE IN TWO BOX OPTIONS

YC-CS4016-2B	Includes: Chainsaw Tool (YC-CS4016), 2 x 20V Batteries (YC-MSB-204), 1 x Dual Slot Charger (YC-DSC-12020)
YC-CS4016-NB	Includes: Chainsaw Tool (YC-CS4016) ONLY. Battery and charger sold separately.

Access product manuals instantly!

SYMBOLS & SAFETY ICONS

1

PRODUCT SAFETY

2

KNOW YOUR TOOL

4

ASSEMBLY & SETUP

5

OPERATION

6

CUTTING TECHNIQUES

7

CHAIN, BAR & LUBRICATION MAINTENANCE

11

MAINTENANCE SCHEDULE

14

TECHNICAL SPECIFICATIONS

15

BATTERY LEVEL INDICATOR

15

CHARGER LED INDICATOR

15

CHARGING TIME

15

MULTI SHARE BATTERY COMPATIBILITY

15

STORAGE

15

TROUBLE SHOOTING

16

ENVIRONMENTAL NOTE

16

WARRANTY INFORMATION

17

CONTACT INFORMATION

17

THANK YOU

18

SYMBOLS & SAFETY ICONS

Refer to this page for all safety labels and warnings used throughout the manual and on product labels.



General Warning

Indicates a potential hazard. Follow all safety instructions before use.



Read Operator's Manual

Read the manual thoroughly before operating the equipment.



Wear Safety Helmet

Always wear a protective helmet to avoid head injuries.



Wear Hearing Protection

Always wear ear protection to prevent hearing damage from loud noise.



Wear Safety Glasses

Shield eyes from flying debris and dust.



Wear Protective Clothing

Wear snug-fitting, full-body clothing to reduce injury risk.



Wear Protective Gloves

Protect hands from cuts, abrasions, and contact with sharp tools.



Wear Safety Footwear

Use safety boots to protect feet from debris and sharp objects.



Do Not Use in Rain or Wet Conditions

Not intended for use in wet conditions.



Keep Hair Tied

Secure long hair to prevent it from being caught in moving parts.



Keep Hands Away

Keep hands away from the chain and moving parts to avoid injury.



Kickback Hazard

Avoid Tip Contact: Never cut with the nose of the guide bar. Contact in this zone causes the tool to instantly drive upward and backward toward the operator, risking severe injury.



Avoid bar nose contact.

Avoid bar nose contact.



Dual-hand Operation

Maximum Control: Always maintain a firm, two-handed grip on the tool handles during operation.



Do Not Dispose in Waterways

Do not dispose of the product in rivers, lakes, or drains. Follow environmental regulations.



Noise Level Rating

The machine emits 104 decibels of sound – wear hearing protection.



Remove Battery Before Servicing

Always remove the battery before cleaning, transporting, or changing accessories.



Battery Inside

This label indicates the package contains a lithium battery.



Only Tool Inside

This label indicates the package includes the tool only. Battery and charger are not included and sold separately.



Do Not Burn

Do not burn the product or its parts. Risk of fire or explosion.



Recyclable Material

This product or packaging is recyclable. Dispose of it according to local recycling regulations.



Do Not Dispose in Household Waste

Dispose in accordance with local electronic/e-waste regulations.



Recycle Yardcore Batteries

Do not discard batteries in the trash. When they reach end of life, recycle through Call2Recycle® at 1-800-822-8837 or visit call2recycle.org.



One Tree Planted

You have planted one tree in your country

⚠️WARNING: Proposition 65 (California Only)
This product can expose you to chemicals including lead and Di(2-ethylhexyl) phtalate (DEHP), which are known to the State of California to cause cancer and birth defects or other reproductive harm.
For more information, visit www.P65Warnings.ca.gov.

IMPORTANT SAFETY INSTRUCTIONS

⚠️ WARNING:

Read all safety warnings and instructions before use. Failure to follow warnings and instructions may result in electric shock, fire, or serious injury.

⚠️ WARNING: READ ALL INSTRUCTIONS

FOR ALL YARDCORE TOOLS

1. Avoid Dangerous Environments – Do not use the tool in damp or wet locations.
2. Do Not Use in Rain – This unit is not weatherproof.
3. Keep Children and Bystanders Away – Maintain a safe distance from the work area.
4. Dress Properly – Avoid loose clothing or jewelry that can become entangled in moving parts. Wear protective gloves, sturdy footwear, and secure your long hair.
5. Wear Eye and Face Protection – Use safety glasses or a face shield. Wear a dust mask if operating in dusty conditions.
6. Use Tool as Intended – Operate the chainsaw only for tasks it was designed for. Misuse may cause injury or damage.
7. Do Not Force the Tool – Operate at the designed speed for optimal performance and safety.
8. Maintain Proper Balance – Do not overreach. Keep firm footing and balance at all times.
9. Stay Alert – Operate the tool with full awareness. Do not use it when tired or under the influence of substances.
10. Store Safely – When not in use, store the tool indoors in a dry, secure location away from children.
11. Maintain the Tool with Care – Keep the bar and chain sharp and clean. Follow maintenance instructions for lubricating and replacing accessories.
12. Inspect Before Use – Always check for damaged guards, misalignment, or broken parts. If damaged, have the unit serviced by an authorized Yardcore service center.

FOR BATTERY-POWERED YARDCORE EQUIPMENT

1. Prevent Accidental Starting – Ensure the power switch is OFF before connecting the battery or moving the unit.
2. Disconnect Battery Before Maintenance – Remove the battery before changing accessories, cleaning, or storage.
3. Use the Correct Charger – Charge only with Yardcore approved chargers. Using the wrong charger can pose a fire risk.
4. Use Only Approved Batteries – Only use Yardcore 20V battery packs. Other batteries may cause injury or damage.
5. Avoid Short Circuits – Keep battery terminals away from metal objects such as keys, nails, or coins. Shorting may cause burns or a fire.
6. Handle Leaks Carefully – If battery fluid leaks, avoid contact. Rinse with water if exposed. Seek medical help if fluid contacts the eyes.
7. Do Not Use Damaged Batteries – Replace any battery that is cracked, punctured, or showing signs of damage.
8. Keep Away from Heat & Flames – Do not expose the battery to fire or temperatures above 130°C (265°F).
9. Charge Within Safe Temperatures – Only charge the battery within the temperature range listed in the manual to prevent overheating or damage.
10. Service by Professionals Only – Repairs should be performed by qualified technicians using Yardcore approved parts.
11. Do Not Modify – Do not open, alter, or repair the battery pack unless instructed in this manual.
12. Charge in a Safe Area – Do not charge the battery near flammable materials or on combustible surfaces.

ADDITIONAL SAFETY PRECAUTIONS FOR CHAINSAW

1. Kickback Prevention – Always hold the chainsaw firmly with both hands and avoid contact with the guide bar tip.
2. Keep All Guards in Place – Never operate the chainsaw without the front hand guard and safety covers.
3. Use the Chain Brake – Always engage the chain brake before starting or moving with the tool.
4. Maintain Proper Chain Tension – A loose chain may derail and cause injury.
5. Use Only with Bar Oil – Never operate without proper chain lubrication.

BATTERY PACK SAFETY WARNINGS

1. Do Not Dismantle, Crush, or Shred the Battery – Doing so may result in fire, explosion, or chemical exposure.
2. Do Not Expose to Fire, Heat, or Direct Sunlight – Exposure to temperatures above 130°C (265°F) may cause the battery to explode.
3. Avoid Short-Circuiting the Terminals – Keep the battery away from metal objects such as keys, nails, or coins. Shorting may cause burns or a fire.
4. Store Batteries in Original Packaging Until Use – This helps prevent accidental damage or short-circuiting.
5. Avoid Mechanical Shock – Do not drop or strike the battery. Physical damage may lead to dangerous failure.
6. If Battery Fluid Leaks – Avoid contact with skin or eyes. In case of contact, rinse immediately with clean water and seek medical attention.

CHARGING SAFETY TIPS

1. Always charge the battery on a non-flammable, flat surface in a well-ventilated area.
2. Do not cover the charger or battery during charging.
3. Do not leave the battery unattended while charging.
4. Unplug the charger from the outlet when not in use.
5. If the battery becomes excessively hot, disconnect it immediately and allow it to cool.

FIRE AND EXPLOSION HAZARDS



1. Keep the tool and battery away from flames, sparks, and flammable surfaces.
2. Do not incinerate the battery pack, even if it is severely damaged or completely worn out.
3. If the battery emits smoke, an unusual odor, or excessive heat, stop using the product immediately and contact Yardcore Support.

STORAGE AND TRANSPORTATION

1. Store the tool and battery in a cool, dry place away from direct sunlight, heat sources, or moisture.
2. Do not transport the battery where the terminals may contact metal objects. Use original packaging or a protective cover to prevent short circuits.
3. Remove the battery from the tool when not in use or during long-term storage.

EMERGENCY RESPONSE INSTRUCTIONS

1. In case of fire, use a Class D fire extinguisher (recommended for lithium-ion batteries).
2. Do not use water to extinguish battery fires.
3. If battery fluid contacts skin or eyes, rinse immediately with clean water and seek medical attention.
4. If you feel dizzy, nauseous, or experience irritation after exposure to battery fumes, move to fresh air and contact a healthcare provider.

ENVIRONMENTAL SAFETY



1. Dispose of this product, battery, and packaging in accordance with local regulations.
2. Do not dispose of batteries in household waste or throw them in the trash. When they reach the end of life, recycle through Call2Recycle® at 1-800-822-8837 or visit call2recycle.org.
3. Help reduce environmental impact by recycling whenever possible.
4. Yardcore is committed to sustainability. Please recycle responsibly.

⚠WARNING: Read all safety warnings and instructions. Failure to follow these warnings may result in electric shock, fire, or serious injury. Save all warnings and instructions for future reference.

The term “power tool” in all warnings refers to your battery-operated (cordless) or mains-operated (corded) power tool.

GENERAL POWER TOOL SAFETY WARNINGS

1. Always follow all safety instructions provided in this manual.
2. Never operate the tool if you are unsure of its function, condition, or surroundings.
3. Use the tool only for its intended purpose.

WORK AREA SAFETY

1. Keep your work area clean and well-lit. Cluttered or dark areas increase the risk of accidents.
2. Do not operate power tools in explosive atmospheres, such as those containing flammable liquids, gases, or dust.
3. Keep children and bystanders away during operation. Distractions can lead to loss of control.

PERSONAL SAFETY

1. Stay alert and use common sense. Never operate the tool when tired or under the influence.
2. Always wear personal protective equipment, including:
 - a. Eye protection
 - b. Hearing protection
 - c. Dust mask (if cutting dry wood)
 - d. Non-slip shoes
3. Prevent accidental starting. Ensure the switch is OFF before connecting the battery.
4. Remove any adjustment tools (like wrenches) before starting.
5. Maintain stable footing and balance at all times.
6. Wear tight-fitting clothing. Avoid jewelry and tie back long hair.
7. Use dust extraction systems if provided.

POWER TOOL USE AND CARE

1. Do not force the tool — use the right tool for the job.
2. Do not use if the switch does not work properly — have it serviced.
3. Disconnect the tool from power/battery when:
 - a. Making adjustments
 - b. Changing accessories
 - c. Storing the tool
4. Store tools safely, out of children’s reach.
5. Keep the tool clean and well-maintained.
6. Use accessories only as specified in this manual.

BASIC MAINTENANCE TIPS

1. Clean chain and guide bar after every use.
2. Refill oil reservoir regularly.
3. Sharpen the chain when cutting performance drops.
4. Inspect chain brake function monthly.
5. Store in a dry, secure location away from heat or flame.

CHAIN SAW SAFETY WARNINGS

1. Keep all body parts clear of the saw chain during operation.
2. Always use right hand on rear handle, left hand on front handle.
3. Use only insulated gripping surfaces when cutting near live wires.
4. Wear full protective equipment: safety glasses, hard hat, chaps, gloves, and boots.
5. Do not operate in trees or on ladders.
6. Operate only from firm, level ground.
7. Be cautious when cutting limbs under tension — spring-back may occur.
8. Use extreme caution when cutting brush or saplings — they may catch and whip.
9. Carry the saw with the bar pointing backward, motor off, and battery removed.
10. Always use the guide bar cover during transport or storage.
11. Follow the manual for lubricating, tensioning, and adjusting the chain.
12. Keep handles dry, clean, and free of oil or grease.
13. Cut wood only. Do not cut plastic, masonry, or other non-wood materials.

SERVICE

1. Have your chain saw serviced by a qualified technician using only identical replacement parts.
2. This ensures that the product’s safety features are preserved.

GLOSSARY OF CHAINSAW TERMS

- Automatic Oiler: A system that automatically lubricates the guide bar and saw chain during use.
- Bucking: The process of cutting a felled tree or log into shorter lengths.
- Bucking Spikes: Metal spikes that help pivot and stabilize the saw against wood while cutting.
- Chain Brake: A safety device that quickly stops the saw chain, typically activated during kickback.
- Chain Saw Power Head: The main body of the chainsaw, excluding the guide bar and chain.
- Drive Sprocket: A toothed wheel that drives the saw chain around the guide bar.
- Felling: The act of cutting down a standing tree.
- Felling Back Cut: The final cut is made on the opposite side of the notching undercut to bring down the tree.
- Kickback: A sudden backward/upward motion of the guide bar caused by chain contact with an object or pinching.
- Low-Kickback Chain: A saw chain that meets ANSI B175.1 safety standards for reducing kickback.
- Normal Cutting Position: Standard body and hand positions during safe bucking or felling.
- Notching Undercut: A notch cut into the tree to control the direction of its fall.
- Reduced Kickback Guide Bar: A guide bar designed to significantly reduce the risk of kickback.

PART LIST & FUNCTION

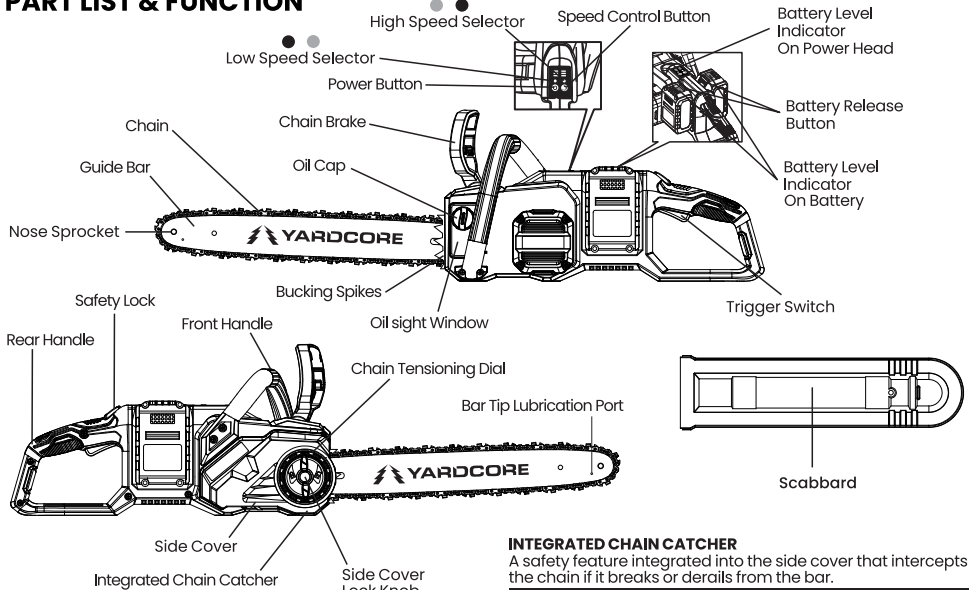

LOW SPEED SELECTOR ● ●

Reduces power and speed for light-duty cutting or battery-saving operation.

HIGH SPEED SELECTOR ● ●

Increases power and speed for heavy duty cutting.

SPEED CONTROL BUTTON

Selects High or Low speed to match cutting conditions.

TRIGGER SWITCH

Starts/stops the saw. **Press the safety lock before squeezing the trigger.**

SAFETY LOCK

Prevents accidental starting. You must press this before pulling the trigger to operate the chainsaw.

BATTERY RELEASE BUTTON

Press to remove the battery from the tool for charging or storage.

BATTERY LEVEL INDICATOR (On PoWer Head)

LED display that shows the current charge level of the battery.

SIDE COVER

Covers the drive sprocket and holds the bar and chain in place. It's removed for chain replacement or cleaning.

SIDE COVER LOCK KNOB

Used to loosen and remove the side cover for maintenance tasks like replacing the chain or cleaning.

CHAIN TENSIONING DIAL

Rotates to adjust chain tension. Proper chain tension is important for safety and performance.

CHAIN

Cutting chain that rotates around the guide bar to cut wood.

CHAIN BRAKE

A safety device that stops the chain almost instantly in case of kickback. Activated by pushing the front handle forward.

NOSE SPROCKET

A fixed (non-replaceable) sprocket to reduce friction and engine wear at the bar tip. Since the sprocket is permanently riveted, it is serviced as part of the complete guide bar assembly.

INTEGRATED CHAIN CATCHER

A safety feature integrated into the side cover that intercepts the chain if it breaks or derails from the bar.

BAR TIP LUBRICATION PORT

A precision-drilled lubrication port located near the guide bar tip. It allows direct grease application to the nose sprocket bearings, reducing heat and extending the service life of the bar.

OIL CAP

Used to seal and refill the chain oil tank. Chain oil is essential for lubricating the bar and chain.

OIL SIGHT WINDOW

A small translucent window that lets you check the oil level inside the tank.

REAR HANDLE

The main grip used when operating the chainsaw. It's where the trigger is located.

FRONT HANDLE

A secondary handle that provides stability and control, especially during horizontal or overhead cuts.

GUIDE BAR

The long flat guide that the chain runs around. It supports and guides the moving chain during cutting.

BUCKING SPIKES

Metal spikes that grip into logs for stability and leverage during cutting.

SCABBARD

A plastic cover that fits over the bar and chain for safe storage and transport.

INSIDE THE BOX

Accessories included vary by model—use the chart below to confirm what's in your box.

PARTS ↓	MODEL →	YC- CS4016-2B	YC- CS4016-NB
	20 V BATTERIES	YC-MSB-204	2
CHAINSAW TOOL		1	1
GUIDE BAR		1	1
CHAIN		1	1
DUAL CHARGER	YC-DCS-12020	1	NA
SCABBARD		1	1

Only use the appropriate accessories intended for this tool. Accessory information can be found on the product packaging, or at our website www.yardcoretools.com

UNPACKING

1. Carefully remove the chainsaw and all accessories from the packaging.
2. Inspect all parts for damage. Do not operate the tool if any components appear damaged.
3. Confirm that all items listed in the "Inside the Box" section are included.
4. Retain packaging for future storage or transport.

Notice: If any parts are missing or damaged, contact Yardcore Support at yardcoretools.com/support.

INSTALLING THE GUIDE BAR & CHAIN



⚠ WARNING: Always remove the battery pack before assembling the tool or handling the chain.
⚠ WARNING: Wear protective gloves when handling the chain. The cutting teeth are sharp and may cause injury.

1. Confirm Chain Direction

- a. Lay the guide bar flat on a table.
- b. Lay the saw chain next to it and identify the direction arrow on the chain.
- c. Position the chain so the cutters on the top of the bar face forward (toward the bar nose).

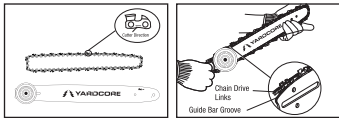

⚠ WARNING: If the chain is installed backwards, the saw will not cut properly and will produce fine dust instead of chips.

2. Fit the Chain to the Guide Bar

- a. Loop the chain around the guide bar groove.
- b. Make sure the drive links sit fully in the bar groove along the entire bar.
- c. Hold the chain in place on the bar so it does not slip out.

3. Remove the Side Cover

- a. Turn the Side Cover Lock Knob counterclockwise to loosen it.
- b. Remove the side cover completely to access the drive sprocket.

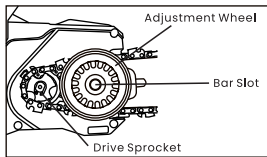

4. Install the Guide Bar and Chain on the Power Head

- a. Place the guide bar onto the mounting area, aligning the bar slot over the mounting stud.
- b. Route the chain around the drive sprocket.
- c. Ensure:
 - i. The chain is engaged on the sprocket.
 - ii. All drive links remain seated in the guide bar groove.
 - iii. The bar is fully seated and can slide slightly for tensioning.

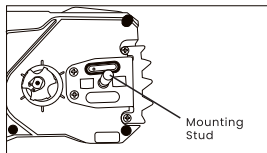

NOTICE:

- **A chain that's too tight will not rotate.**
- **Loosen the side cover knob slightly and turn the chain tensioning dial counterclockwise once.**
- **Lift the bar tip and retighten.**

5. Reinstall the Side Cover (Hand-Tighten Only)

- a. Install the side cover back onto the saw.
- b. Confirm the cover sits flat and the slots align correctly.
- c. Turn the Side Cover Lock Knob clockwise until snug, but do not fully tighten yet (leave it slightly loose so the bar can move for chain tensioning).

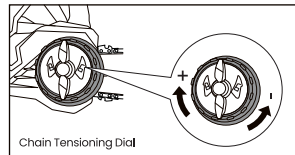
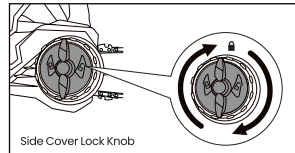

6. Set Chain Tension (Using the Chain Tensioning Dial)

- a. Turn the Chain Tensioning Dial clockwise to tighten the chain.
- b. Check the chain along the bottom of the bar.
- c. The chain should sit against the bar with no visible sag.
- d. Pull the chain by hand (with gloves). It should move smoothly around the bar.
- e. Chain Saw/Tension Check
- f. Target slack: approximately 1.3 mm (0.05 in) at the bottom of the guide bar.
- g. The drive links should stay engaged in the bar groove when you gently pull the chain away from the bar.
- h. Do not overtighten: An overtightened chain can overheat, wear the bar/chain faster, and reduce runtime.

7. Final Tightening (Important)

- a. Lift the nose (tip) of the guide bar upward to remove play.
- b. While holding the bar nose up, turn the Side Cover Lock Knob clockwise to fully tighten and lock the assembly.
- c. Recheck chain tension after tightening. Adjust if needed.

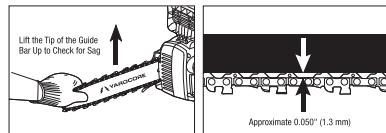

Final Check (Before Installing Battery)

- a. Side cover is seated and aligned properly
- b. Side Cover Lock Knob is fully tightened
- c. Chain is correctly oriented (top cutters face forward)
- d. Chain moves freely by hand and has proper tension

ADDING BAR & CHAIN OIL

⚠ WARNING: Always remove the battery pack from the product when you are assembling parts, making adjustments, cleaning, or when the product is not in use.

1. Place the chainsaw on a level surface.
2. Unscrew the oil tank cap (Fig. 6)
3. Fill with Bar & Chain Oil.
4. Use the oil sight window to verify the oil level before each use.
5. Reinstall the cap securely.

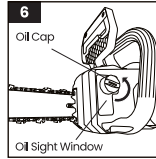

NOTICE: Always fill the oil tank before each use to prevent damage.

NOTICE: Never add engine oil, Motor Oil, Used Oil into the oil tank

Recommended Bar & Chain Oil

Use a tackified SAE 30 bar & chain oil, labeled all-season or summer grade.

Similar to Oregon 54-026 or equivalent.

Before First Use

Battery fully charged
Bar & chain oil-filled
Chain tension checked
Chain brake tested

ATTACHING/DETACHING MULTI SHARE BATTERY

Do not attach hatter until assembly is complete.

NOTICE: Fully charge the battery pack before first use.

To Attach

Align the battery ribs with the mounting slots in the machine's battery port and slide the battery pack until it snaps into position (Fig. 7a).

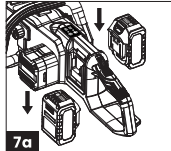

To Detach

- Press the battery release button, and the battery pack will disengage from the latch (Fig. 7b).
- Grasp the battery pack and remove it from the machine.

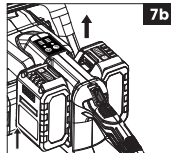

⚠ WARNING: Always be aware of the location of your feet, children, or pets when pressing the battery release button. Serious injury could result if the battery pack falls. NEVER remove the battery pack from a high location.

BEFORE STARTING THE CHAIN SAW



1. Remove the battery pack.
2. Make sure that the chain is properly mounted and correctly tensioned.
3. Lift the tip of the guide bar up to check for chain sag. The chain should be snug but turnable by hand.
4. Check that the side-cover knob is tight.
5. Check oil level and fill if needed.
6. Inspect the cutting teeth for sharpness.
7. Ensure chain lubrication is active.
8. Test the kickback brake handle moves freely and resets properly.
9. Stand upright in a relaxed position.
10. Ensure the chain is not touching anything.
11. Hold the saw with both hands: right hand on rear handle, left on front.
12. Ensure solid footing; watch for obstacles.

CHECKING BAR & CHAIN OIL

⚠ WARNING: Always remove the battery pack before checking or refilling the oil tank.

1. Place the chainsaw on a level surface.
2. Check the oil inspection window to confirm the oil level.
3. If the level is low, refill with Yardcore Bar & Chain Oil or equivalent.
4. Tighten the oil cap securely.
5. Refer to Section assembly section for full oil-filling instructions.

NOTICE: Always check and refill the oil tank before each use to ensure proper lubrication and prevent damage.

TURNING ON/OFF THE MACHINE (Fig. 8a)

1. Press the power button once to switch on the machine.
2. The indicator light will illuminate when the tool is ready for operation.

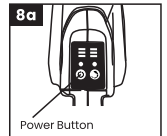

TO TURN OFF:

1. Press and hold the power button for 3 seconds to turn off manually.

AUTO POWER-OFF:

1. If the machine is idle for 1 minute, it will automatically power off to save energy.

TO START THE MACHINE (Fig. 8b)

NOTICE: Before starting, make sure the battery is installed, the chain is tensioned, and the area is clear of obstructions.

1. Push the chain brake handle forward to engage the brake (The motor cannot start in this position).
2. Pull the chain brake handle back toward the front handle to disengage the brake.
3. Push the safety lock-off lever forward using your thumb.
4. While holding the lock-off lever forward, squeeze the trigger to start the motor.

NOTICE: The motor starts only when the chain brake is disengaged, the lock-off lever is pushed forward, and the trigger is pressed.

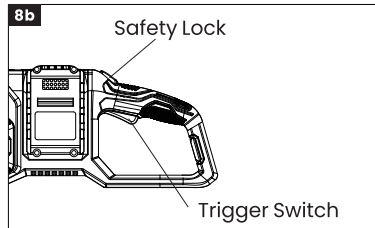

TO STOP THE MACHINE



1. Release the trigger switch to stop the chain movement.
2. Push the chain brake handle forward to engage the brake.
3. Press and hold the power button for 3 seconds to shut down the saw (if not already auto-off).
4. Remove the battery pack during breaks, transport, or storage.

⚠ WARNING: Always remove the battery pack from the machine during work breaks and after finishing work.

CHANGING SPEED MODE (FIG. 9)

This machine features two speed modes, which can be toggled using the speed control button.

- Press the speed control button to cycle between speed modes.
- The speed indicator lights will show the current mode:
 - Left light = Low speed
 - Right light = High speed

Low Speed Mode provides better control and longer operating time per charge.

High Speed Mode delivers more cutting power for tougher tasks.

NOTICE: Speed can only be changed when the trigger switch is released. The machine will retain your last selected speed mode when restarted.

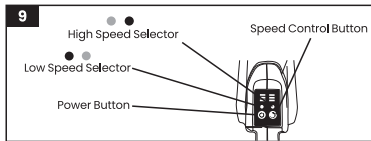

USING THE CHAIN BRAKE (FIG. 10)

The chain brake is a safety feature that stops the chain in the event of kickback.

- Engage the brake by pushing the chain brake handle forward.
- Disengage the brake by pulling the handle back toward you.

⚠ WARNING: Always test the chain brake before use. The chain should stop immediately when the brake is engaged.

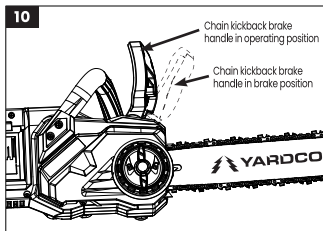

1. PREPARING FOR CUTTING

⚠ WARNING: Improper grip or stance can cause loss of control, leading to serious injury. Always maintain proper posture and awareness of the guide bar tip.

1.1 GRIP THE CHAIN SAW PROPERLY (FIG. 11)

- Always hold the saw with both hands.
- Place your right hand on the rear handle, even if you are left-handed.
- Place your left hand on the front handle, with your thumb wrapped underneath.
- Maintain a firm, secure grip at all times.

NOTICE: Never operate the chain saw with one hand. Two-handed control reduces the risk of kickback.

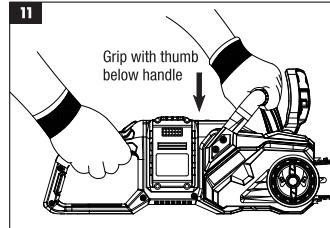

1.2 STAND IN A STABLE POSITION

- Keep your feet shoulder-width apart for balance.
- Slightly bend your knees and relax your upper body.
- Keep your weight evenly distributed and avoid leaning forward or backward.
- Ensure solid footing — avoid wet, uneven, or unstable ground.
- Do not overreach; stay close to your cutting area.

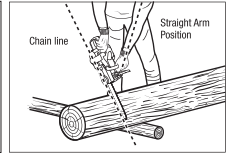
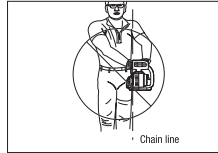

2. CUTTING

⚠ WARNING: Always ensure stable footing and hold the chain saw firmly with both hands while the motor is running. Do not attempt any cuts until you are confident in your grip, stance, and understanding of the workpiece.

Before performing advanced operations like bucking, limbing, or felling, practice cutting a few small logs to gain familiarity with the saw's behavior and cutting response.

2.1 BASIC CROSS-CUTTING

Cross-cutting refers to cutting across the grain of a log, typically when cutting it to length.

1. Place the log on a firm, stable surface.
2. Stand in a secure and balanced position, feet shoulder-width apart.
3. Ensure the chain saw is at full speed before beginning the cut.
4. Start the cut by gently pressing the guide bar against the wood. Use only light pressure — let the saw do the cutting.
5. Maintain a smooth, steady cutting motion. Avoid forcing the saw into the cut.
6. Just before finishing the cut, reduce pressure to avoid sudden breakthrough.
7. Release the trigger as soon as the cut is completed and allow the chain to stop.

3. TREE FELLING TECHNIQUES

⚠ WARNING: Tree felling is extremely dangerous. Plan thoroughly, wear the proper protective gear, and never work alone. Always maintain a clear escape path and use extreme caution.

3.1 HAZARDOUS CONDITIONS

Before felling a tree, inspect the environment and the tree itself. Do not attempt to cut trees under the following conditions:

- During periods of high wind, heavy rain, or poor visibility
- Trees leaning at extreme angles
- Trees with dead limbs, loose bark, or hollow trunks
- Near utility lines, buildings, or vehicles

⚠ WARNING: If a tree makes contact with a power line, do not approach. Stay clear and notify the utility company immediately.

3.2 PREPARATION FOR TREE FELLING

Follow these precautions before starting any felling work:

- When bucking and felling operations are being conducted by two or more people, maintain a minimum distance of twice the height of the tree between operations.
- Never fell a tree in a way that may endanger a person, damage property, or strike a utility line.
- If the tree contacts a utility line, notify the utility company immediately.
- The operator should always stand on the uphill side of the terrain, as felled trees may roll or slide downhill after cutting.
- Before cutting:
 - Identify one or more escape routes in case the tree falls in an unintended direction.
 - Clear the base of the tree and the surrounding area of all debris and obstructions.
 - Create a clear retreat path approximately 135° from the intended line of fall. This path should angle back and diagonally away from the tree.
 - See Fig. 14 – Safe Retreat Angle

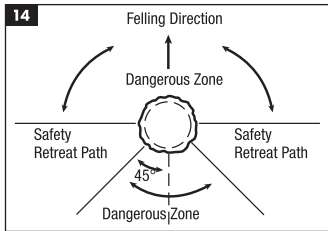

- Assess the natural lean of the tree, the position of major branches, and the wind direction. These factors help determine the tree's likely fall direction.
- Remove any dirt, stones, loose bark, nails, staples, or wire from the trunk where cuts will be made.

⚠ WARNING:

Tree felling should only be performed with proper planning, technique, and awareness of surroundings. Failure to follow these guidelines can result in serious injury, death, or property damage.

3.3 NOTCHING UNDERCUT

Begin by making a notch on the side of the tree facing the intended direction of fall.

- The notch should be approximately 1/3 the diameter of the tree.
- Start with the lower horizontal cut, which helps prevent pinching.
- Then make the top angled cut to meet the lower cut, forming a notch.

- Remove the wedge and inspect the notch for proper depth and angle.
- See Fig. 15 – Proper Notch and Back Cut

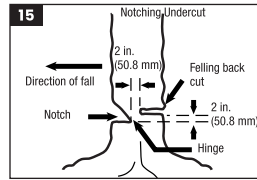

⚠ WARNING: Never attempt to start a cut with the guide bar tip. Doing so may result in kickback.

4. BUCKING

Bucking is the process of cutting a felled tree or log into shorter sections. It often involves logs on the ground or supported at one or both ends.

4.1 BEFORE YOU BEGIN

- Always stand with firm, balanced footing, keeping your weight evenly distributed.
- Whenever possible, elevate and support the log using other logs, limbs, or chocks to prevent the chain from pinching or contacting the ground.
- Maintain a clear cutting area free of rocks, debris, or other obstructions.

⚠ WARNING: Avoid contact between the guide bar nose and any surrounding objects. Sudden contact can cause dangerous kickback.

4.2 CUTTING METHODS

4.2.1 OVERBUCKING (FIG. 16a)

Cutting from the top side of the log with the bottom of the guide bar.

- Apply light downward pressure.
- The saw may pull slightly away from you—maintain control.

4.2.2 UNDERBUCKING (FIG. 16b)

Cutting from the underside of the log with the top of the guide bar.

- Apply light upward pressure.
- The saw may push back toward you—brace and maintain a firm grip.

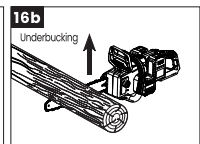
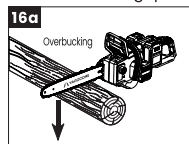

4.3 BUCKING SCENARIOS

4.3.1 Log Supported Along the Entire Length

Cut from the top (Overbuck) to avoid cutting into the earth. Refer to Fig. 17.

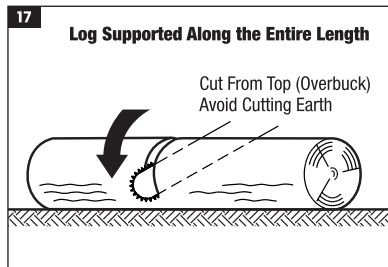

4.3.2 Log Supported on One End Only

- Start with an underbuck cut from the bottom – approx. 1/3 of the log's diameter, to avoid splintering.
- Complete the cut from the top (overbuck) – cutting through the remaining 2/3.
- Refer to Fig. 18

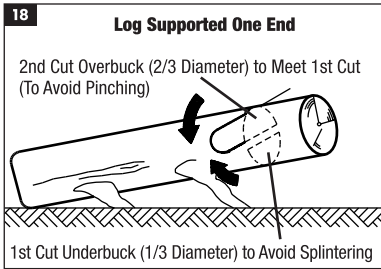

4.3.3 Log Supported on Both Ends

- Start with an overbuck cut from the top – approx. 1/3 of the diameter, to avoid splintering.
 - Finish with an underbuck cut from the bottom – through the remaining 2/3, to avoid pinching.
- Refer to Fig. 19

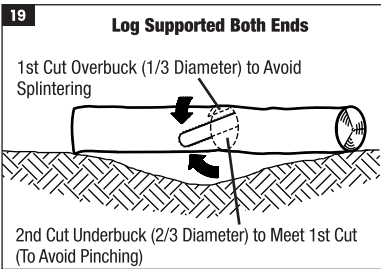

4.3.4 Cutting on a Slope

- Always stand uphill of the log during cutting. This ensures safety in case the log rolls or shifts unexpectedly.

4.3.5 Finishing the Cut Safely

- As you approach the end of the cut, ease off cutting pressure – do not release your grip.
- Avoid chain contact with the ground, which can dull the chain and increase the risk of kickback.
- After completing the cut, wait for the chain to come to a complete stop before walking or repositioning.
- Always stop the motor before moving to the next log or location.

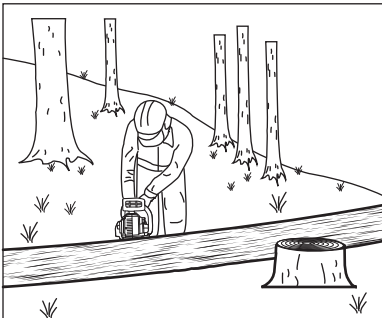

5. LIMBING A DOWNED TREE (FIG.21)

Limbing is the process of removing branches from a felled tree.

Limbing Procedure:

1. Stand on the opposite side of the limb being cut.
2. Begin at the base of the trunk and work toward the top.
3. Leave large support limbs in place until smaller limbs are removed.
4. Rest the saw on the limb, then start the cut with light pressure.
5. For branches under tension, cut from the bottom up to avoid pinching the bar.

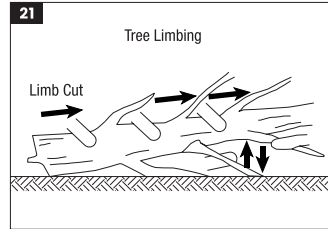

⚠ WARNING: Limbing carries a high risk of kickback due to branch angles and tip contact. Never cut with the upper tip of the guide bar.

4. AVOIDING PINCHING AND KICKBACK

Pinching occurs when the wood closes in on the guide bar during a cut. This can lead to sudden saw stoppage or kickback.

To avoid this:

- Analyze the tension and compression zones of the log.
- Use proper overbuck/underbuck technique depending on how the log is supported.
- Insert a plastic or wooden wedge into the cut to keep it open if needed.
- Never twist the saw to remove it from a pinched position. Stop the motor and remove it carefully.

⚠ WARNING: If the saw becomes pinched in a cut, release the trigger, remove the battery pack, and then carefully lift out the bar – do not force or yank it.

5. BODY POSITION AND CONTROL

- Always stand with feet shoulder-width apart.
- Keep your left arm straight with your elbow locked to help resist kickback.
- Hold the saw close to your body for better control and reduced fatigue.
- Do not position yourself directly behind the saw – stand slightly to the left of the cutting line.

NOTICE: Proper body alignment not only improves safety but also reduces user fatigue during extended cutting sessions.

6. REMINDER: LET THE SAW DO THE WORK

- Do not apply excessive force while cutting.
- A properly sharpened chain will feed itself into the wood with moderate pressure.
- Forcing the saw can cause overheating, chain dulling, or kickback.

6.1 KICKBACK SAFETY & PREVENTION

⚠ WARNING: Kickback is one of the most dangerous reactions when operating a chainsaw. It can cause a sudden, violent motion of the guide bar toward the operator, resulting in serious injury or death.

NOTICE: Kickback is caused by misuse – not the tool itself. With the right precautions and awareness, it can be prevented.

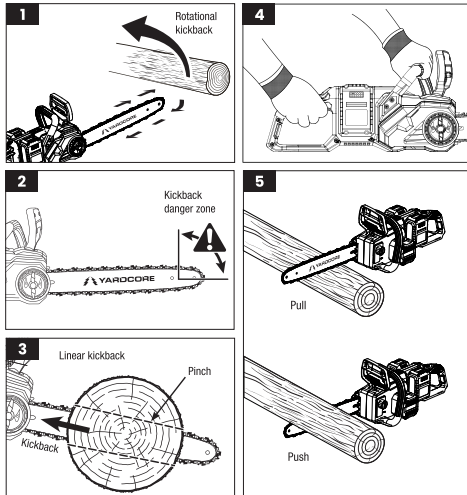

Kickback can occur when:

- The nose or tip of the guide bar contacts an object.
- The wood closes in and pinches the saw chain, particularly along the top of the guide bar.

Tip contact may cause a sudden reverse reaction that forces the guide bar up and back toward the operator. Chain pinching on the top of the guide bar may drive the bar straight back toward the user.

Either of these reactions can result in loss of control and serious injury.

Do not rely solely on the saw's built-in safety features. Kickback is preventable through proper operation, awareness, and control.

6.1.1 AVOIDING KICKBACK

- Maintain a firm grip with both hands on the saw. Wrap thumbs and fingers completely around the handles (Fig. 4).
- Never overreach or cut above shoulder height. Maintain control and avoid tip contact at all times.
- Use only YARDCORE-approved guide bars and chains. Incorrect replacements may cause chain breakage or increased kickback.
- Sharpen and maintain the chain according to YARDCORE specifications.

WARNING: Reducing the depth gauge height increases the risk of kickback.

- Inspect the cutting area for obstructions like logs, branches, fence wire, or other materials that could contact the guide bar nose.
- Cut at full speed. Fully engage the trigger before entering the cut and maintain speed throughout.
- Maintain proper footing and body position at all times. Stay balanced and alert.
- Understand cutting forces – push and pull reactions affect saw movement (Fig. 5):
- Cutting on the bottom edge of the bar pulls the saw forward.
- Cutting on the top edge of the bar pushes the saw backward.

6.1.2 SAFE OPERATING PRACTICES

- Always keep both hands on the saw.
- Do not cut with one hand.
- Maintain a secure stance with knees slightly bent.
- Keep the saw close to your body for better control.
- Understand how the saw reacts when cutting different materials.

⚠ **WARNING:** Kickback can be controlled by the operator if proper precautions are taken. Always maintain control and stay alert when cutting. Practice safe habits to avoid accidents and injury.

6.1.3 KICKBACK SAFETY DEVICES ON THIS CHAIN SAW

This chainsaw is equipped with multiple safety features designed to reduce the risk of kickback. These devices work in conjunction with safe operating practices and should never be relied upon as a substitute for proper technique and awareness.

6.1.4 CHAIN BRAKE

The chain brake is designed to stop both the motor and the chain rotation in the event of kickback. It is triggered by the forward movement of the chain kickback brake handle or by inertial forces during sudden backward rotation.

⚠ **WARNING:** Never modify or disable the chain brake. Doing so can result in serious injury.

Before each use, confirm that the chain brake is functioning properly:

To test the chain brake:

1. Place the chainsaw on a flat, bare surface with no obstructions near the bar or chain.
2. Pull the chain brake handle (front hand guard) back toward the front handle to disengage the brake.
3. Start the chainsaw.
4. Push the chain brake handle forward. A properly functioning brake will stop the chain immediately.

If the chain brake does not function correctly, do not use the saw until inspected and repaired by a qualified service technician.

⚠ **WARNING:** Always ensure the chain brake is operational before each use.

⚠ **WARNING:** If the brake mechanism is clogged with wood chips or debris, the chain brake may not activate correctly. Keep the area clean at all times.

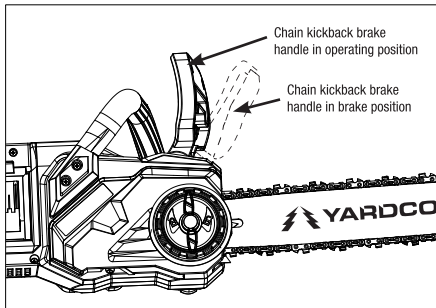

6.1.5 LOW KICKBACK SAW CHAIN

This saw is equipped with a certified low kickback chain, designed to reduce the intensity of kickback events.

- Depth gauges (rakers) in front of each cutter help limit how deeply the cutter can bite into wood in the kickback zone.
- Only use replacement chains that are:
 - Equivalent to the original YARDCORE model, or
 - Certified low kickback chains per ANSI B175.1 standards.

NOTICE: As the chain is sharpened throughout its service life, it may lose some of its original low kickback properties. Use extra caution as the chain ages.

6.2 GUIDE BAR

This saw includes a small-radius nose guide bar, which significantly reduces the potential for kickback.

- Always replace the guide bar with the approved YARDCORE replacement part listed in this manual.
- Do not use bars with larger nose radii unless specifically certified as low kickback compatible.

⚠ **WARNING:** Kickback safety devices are not a substitute for proper cutting technique. Always follow safe operating practices and remain alert to avoid injury.

6.2.1 GUIDE BAR MAINTENANCE

Proper guide bar maintenance ensures safe operation, consistent cutting performance, and a longer service life for your chainsaw. Daily cleaning and regular inspection are essential.

6.2.2 BENEFITS OF A SMALL RADIUS NOSE

This chainsaw is equipped with a small-radius nose guide bar, which helps reduce the risk of kickback.

Advantages:

- Lower kickback potential
- Improved control during plunge cuts
- Increased operator safety

6.2.3 CLEANING THE BAR GROOVE AND OIL HOLES

The bar groove and oil holes must be kept clean for proper lubrication and safe operation.

Daily Cleaning Steps:

1. Remove the guide bar and chain.
2. Clean the bar groove using a groove cleaner or thin tool.
3. Clear the lubrication holes using a wire or compressed air.
4. Wipe down the entire bar and inspect for damage.

6.2.4 INSPECTING THE GUIDE BAR

The guide bar should be inspected after every use. Minor wear is normal, but the following conditions require immediate attention:

Replace the bar if you notice:

- Excessive wear inside the bar rails is causing the chain to lean or flop.
- Bent or warped guide bar.
- Cracked, broken, or spread rails.
- Feathering or burring of the bar rails — smooth immediately using a flat file.

6.2.5 LUBRICATING THE BAR NOSE SPROCKET

The guide bar tip includes a sprocket that must be lubricated weekly to prevent overheating and wear. To lubricate the sprocket:

1. Use a grease syringe filled with chain oil.
2. Inject grease through the lubricating hole on the guide bar tip.
3. After lubrication, rotate the sprocket by hand to distribute the grease.
4. Ensure the lubrication holes and chain groove are clean before reinstalling.

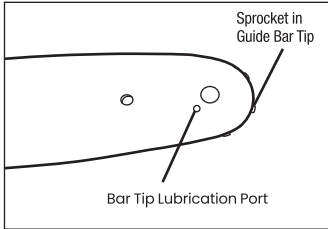

⚠ WARNING: Always disconnect the battery or spark plug before performing maintenance. Never operate the saw with a damaged or improperly lubricated guide bar.

6.3 REPLACING THE BAR AND CHAIN

Check chain tension before every use.

1. Remove the battery pack.
2. Allow the chain to cool before adjusting.
3. Turn the Chain Tensioning Dial clockwise to tighten, counterclockwise to loosen.
4. A properly tensioned chain should sit snugly against the bar but still move freely by hand.
5. Re-check tension after 5–10 minutes of cutting.

⚠ WARNING: Always remove the battery pack before performing any maintenance.

⚠ WARNING: Always wear gloves when handling the bar and chain — they are sharp and may contain burrs.

⚠ WARNING: Never touch or adjust the chain while the motor is running.

NOTICE: Always use the yardcore bar and chain.

6.3.1 Disassembling the Worn Bar and Chain

1. Remove the battery. Allow the saw to cool. Tighten the oil tank cap.
2. Place the saw on its side with the side cover facing up.
3. Wearing gloves, turn the side cover lock knob counterclockwise and remove the cover.
4. Turn the Chain Tensioning Dial toward the front handle to loosen the chain.
5. Remove the bar and chain from the mounting surface.
6. Remove the worn chain from the bar.

NOTICE: This is a good time to inspect the drive sprocket for wear or damage.

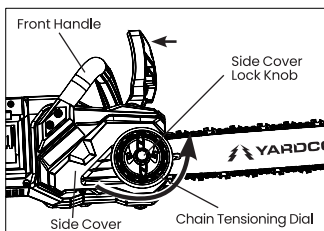

6.3.2 Assembling the New Bar and Chain

Refer to Section – ASSEMBLY & SETUP – INSTALLING THE GUIDE BAR & CHAIN

6.4 CHAIN MAINTENANCE

⚠ WARNING: Remove the battery before performing maintenance.

⚠ WARNING: Always wear gloves when handling the chain.

- Use only low-kickback chains for safety.
- A properly sharpened chain cuts smoothly and requires minimal pressure.
- A dull chain increases:
- Vibration
- Physical strain
- Motor wear
- Cutting inaccuracy

Signs Your Chain Needs Sharpening:

- Fine dust instead of chips
- Must be forced through wood
- Cuts curve to one side

NOTICE: Inspect the drive sprocket for wear when replacing the chain.

6.4.1 How to Sharpen the Cutters

1. Remove the battery. Wear gloves.
2. Ensure chain is properly tensioned.
3. Use a 0.177" (4.5 mm) round file and holder.
4. Keep file level with top plate and use a 30° sharpening angle (Fig. 30–31).
5. File with light, firm strokes, always away from the body.
6. File all left cutters, then switch sides to file right cutters.
7. Clean file with a wire brush often (Fig. 32).

⚠ WARNING: A dull or misfiled chain can cause motor over-speed and injury.

⚠ WARNING: Improper sharpening increases kickback risk.

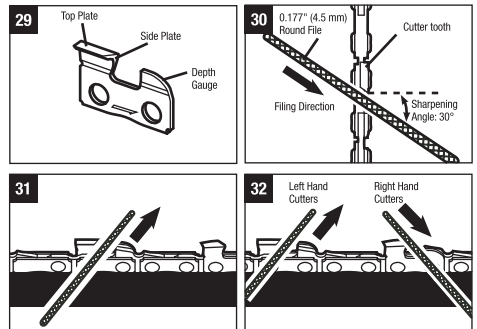

6.4.2 Top Plate Sharpening Angles (Fig. 33)

Angle	Description
Correct: 30°	Use file holder for accuracy.
< 30°	Dull tooth, poor cutting.
> 30°	Feathered edge, dulls quickly.

33

Top Plate Sharpening Angles

LESS THAN 30°

MORE THAN 30°

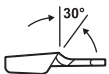

CORRECT

INCORRECT

INCORRECT

6.4.3 Side Plate Angle (Fig. 34)

Angle	Description
Correct: 55°	Achieved with proper file and holder.
Hook	Too small file or angle too low – high kickback risk.
Backward Slope	Too large file or angle too high – poor cutting performance.

34

Side Plate Angle

Hook

Backward Slope



CORRECT

INCORRECT

INCORRECT

6.4.4 Depth Gauge Clearance (Fig. 35–36)

1. Use a 0.025 in. (0.6 mm) depth gauge tool.
2. File all gauges uniformly with a flat file and depth gauge jointer.
3. Match filing direction to the adjacent cutter to avoid damage.

35

Depth Gauge Clearance

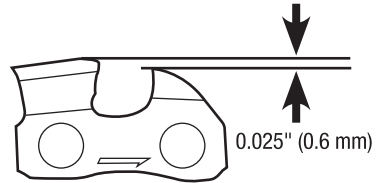

36

Depth Gauge Jointer

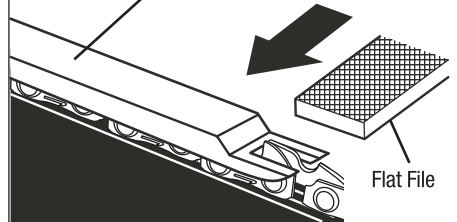

6.5 TRANSPORTING AND STORING

1. Always remove the battery before storage or transport.
2. Install the guide bar sheath before handling.
3. Store indoors, in a dry, child-inaccessible location.
4. Keep clear of corrosive chemicals (e.g., fertilizers, de-icers).

6.6 CLEANING

- After each use, clean debris from the chain and guide bar with a soft brush.
- Wipe the saw's surface with a clean cloth moistened with a mild soap solution.
- Remove the side cover, then use a soft brush to clean debris from the guide bar, saw chain, sprocket, and side cover.
- Always clean out woodchips, sawdust, and dirt from the guide bar groove when replacing the saw chain.

Recommended Oregon 38278 4.5 mm Chainsaw Sharpening Kit.

MAINTENANCE SCHEDULE

COMPONENTS	WHAT TO CHECK	RECOMMENDED SCHEDULE	HELPFUL NOTES
Battery Pack	Cracks, swelling, leaks, overheating	Before each use	Stop using and contact Yardcore Support if anything seems off.
Battery Terminals	Dirt, corrosion, or bent contacts	Weekly or every 5 uses	Wipe gently with a dry cloth. No liquids or metal tools.
Battery Charge Level	Charge condition before and after use	Before & after each use	Avoid long-term storage at 0% or 100% charge.
Battery Storage	Kept in a cool, dry, battery-safe location	Ongoing	Store at ~50% charge if not using for more than a month.
Charger & Cable	Frayed cord, heat marks, bent plug	Monthly	Replace if damaged. Unplug when not in use.
Charging Ports	Dust or debris in charging slots	Monthly	Use a soft brush or cloth to clean.
Motor Housing & Vents	Grass, dust, or buildup blocking airflow	After each use	Wipe with a dry cloth. Keep vents clear.
Trigger & Handle Area	Sticky trigger, slow response	Weekly	Clean gently. If sticky, contact service.
Chain Tension	Proper tension maintained	Before each use	Adjust as needed. See "Adjusting Chain Tension" section.
Saw Chain Condition	Dull, bent, worn, or damaged links	Monthly	Sharpen or replace if cutting is poor.
Guide Bar Condition	Bar groove clean, no visible damage	Monthly	Clean and inspect. Replace if bent or worn.
Sprocket Area	Debris buildup or wear	Every 2-3 uses	Remove bar and chain to clean.
Chain Brake	Engages and resets properly	Every 2-3 uses	Test before each use. Clean if sticky.
Oil Tank & Cap	Oil level, cap seal, and cleanliness	Before each use	Refill if low. Clean cap and tank if clogged.
Oil Delivery System	Chain is being oiled during use	Weekly	Run saw and check for oil on chain. Clean oil port if clogged.
Hand Guard	Loose, cracked, or damaged	Weekly	Clean and replace if damaged.
Main Body & Handles	Cracks, loose joints, or damage	Monthly	Especially check if tool was dropped.
Screws & Bolts	Loose or missing fasteners	Monthly	Tighten carefully. Overtightening may damage plastic housings.
Noise/Vibration	Excessive shaking or loudness	While operating	Could indicate loose chain, sprocket, or worn parts.
Tool Storage Area	Dry, clean, temperature-controlled space	Ongoing	Avoid direct sunlight or extreme temperatures.
Plastic Surfaces	Dirt, sap, or stuck debris	After each use	Wipe with soft dry cloth. Avoid water or harsh cleaners.
Ventilation Slots	Clogged or dusty	Weekly	Clean with brush or vacuum.
General Inspection	Any signs of wear, damage, or missing parts	Monthly	Quick visual check can help catch issues early.

TECHNICAL SPECIFICATIONS

	YC-CS4016-2B	YC-CS4016-NB
RATED VOLTAGE	40 V MAX (2x20V)**	
RATED POWER	1600 W	
CHAIN SPEED	13.4 m/s	
BAR AND CHAIN	Equivalent To Oregon 27857	
GUIDE BAR LENGTH	16" (400 mm)	
CHAIN PITCH	3/8" LP	
CHAIN GAUGE	0.050" (1.3 mm) Narrow Kerf	
DRIVE LINKS	56	
OIL TANK	120 ml *Bar & Chain Oil Not Included	
BATTERY TYPE	Lithium Ion	NA
BATTERY MODEL	YC-MSB-204 20V 4.0Ah	NA
CHARGER MODEL	YC-DSC-12020 (Dual Slot Charger)	NA
CHARGER RATING	Input: 120V~ 2.0A max Output: 2 x 40W	NA
TOOL WEIGHT	11.2 Lbs/ 5.1 Kgs	8.5 Lbs/ 3.90 Kgs
TOOL DIMENSIONS LXWXH	850x230x240 mm FULLY ASSEMBLED 33.4x9.0x9.4" (With Bar and Chain)	

**Voltage measured without workload. Initial battery voltage reaches maximum of 20 volts. Nominal voltage is 18 volts.
*Similar to Oregon 54-026 Premium Bar and Chain Oil and Lubricant for Chainsaws

*BATTERY LEVEL INDICATOR On Battery On Power Head

LED ON BATTERY				
% OF CHARGE	0 to 25	25 to 50	50 to 75	75 to 100
NO LOAD LOW SPEED	<5 mins	30	32	50
LOAD HIGH SPEED	<5 mins	22	24	35
WITH LOW SPEED	<3 mins	13	15	20
LOAD HIGH SPEED	<3 mins	10	12	16
BATTERY IMPLICATIONS	Charge the battery		Best for long term storage	
LED ON POWER HEAD				

*Times shown are estimates. Actual performance may vary with conditions and usage.

CHARGER LED INDICATOR

	GREEN LED*		RED LED	
Battery Is Charging	Without Battery	With Battery	Battery Error Detected	Charging Error**
Wait for battery to finish charging	No Battery Detected	100% Charge	Read Trouble shooting Page	Unplug charger & battery

*YC-DSC-12020 has 2 Battery Slots with 2 LED lights each
YC-SSC-12020 has 1 Battery Slot with 2 LED lights
** If charging takes unusually long time, the charger stops and shows a solid red light.
Only use Multishare Yardcore 20V 4 Ah Batteries

CHARGING TIME

Charger Model	Battery Slots	Charging 1 Battery*	Charging 2 Batteries*
YC-DSC-12020 <small>(Dual Slot Charger)</small>	2	120 mins	120 minutes <small>(charges both simultaneously)</small>
YC-SSC-12020 <small>(Single Slot Charger)</small>	1	120 mins	NA

*Charging times based on Yardcore MultiShare 20V 4.0Ah battery packs under standard conditions. Actual times may vary depending on battery age, temperature & usage.

MULTI SHARE BATTERY COMPATIBILITY YC-MSB-204 20V 4 Ah Lithium

*TOOLS COMPATIBLE**		CHARGING	
20V Series	CORDESS BRUSH CUTTER	YC-BC4013	SINGLE SLOT CHARGER
2x20V 40V Max	CORDESS CHAINSAW	YC-CS4016	DUAL SLOT CHARGER
	CORDESS LEAF BLOWER	YC-LB40120	

*Yardcore is continuously expanding its battery platform. Please visit www.yardcoretools.com for the most up-to-date compatibility list.
**Some tools include batteries and chargers, while others are sold separately. Always check product details before purchasing.

STORAGE

TOOL STORAGE

- Always remove the battery pack from the tool after use.
- The chainsaw includes a hanging slot for wall-mounted storage.
- Clean the tool thoroughly to remove wood particles, grass, and debris before storing.
- Store indoors in a dry location where the tool is protected from moisture, direct sunlight, and mechanical damage.
- Do not store the tool near heat sources or in areas with high humidity.

BATTERY STORAGE

- Remove the battery from the tool and store it separately.
- Store the battery at approximately 50-75% charge (3 bars on the Battery Level Indicator on Battery).
- Do not store the battery fully charged or completely discharged for extended periods.
- Store in a cool, dry place away from direct sunlight, extreme temperatures, and flammable materials.
- If storing for more than 3 months, check and recharge the battery every 3 to 6 months.

CHARGER STORAGE

- Unplug the charger from the wall outlet when not in use.
- Store the charger in a clean, dry area away from moisture and dust.
- Avoid storing the charger in temperatures below 0°C (32°F) or above 40°C (104°F).
- Do not coil the power cord tightly during storage.

CHAIN STORAGE

Proper storage of the chainsaw chain helps prevent rust, preserves cutting performance, and extends its service life.

- Before storing the chain:**
 - Clean the chain thoroughly to remove oil, sap, sawdust, and debris.
 - Dry completely to prevent moisture buildup.
- For safe storage:**
 - Store the chain in its original packaging or a protective container to prevent damage or tangling.
 - Apply a light coat of chain oil to prevent corrosion during long-term storage.
 - Keep in a dry, cool location, away from direct sunlight or extreme temperatures.
- Before next use:**
 - Inspect the chain for rust, cracks, or dull cutters.
 - Replace if damaged or excessively worn.

TROUBLE SHOOTING

The table below outlines common issues and simple troubleshooting steps you can take if your Yardcore chainsaw isn't working as expected. If the issue persists after following these suggestions, please contact Yardcore Customer Support or visit an authorized service center.

⚠ **WARNING:** Always switch off the tool and remove the battery before performing any checks or maintenance.

Problems	Possible Causes	Corrective Action
Chainsaw does not start	Battery not inserted properly	Remove and reinstall the battery securely.
	Battery is depleted	Fully recharge the battery.
	Battery is too hot or too cold	Allow battery to return to room temperature.
	Lock-off button not pressed	Press and hold lock-off button, then squeeze trigger
	Chain brake is engaged	Pull chain brake handle back toward front handle
	Internal protection mode activated	Release trigger, wait a moment, and try again
	Poor contact between battery and tool	Clean terminals and reinsert battery
Motor runs, but chain does not move	Chain is too tight	Adjust chain tension
	Chain not seated on sprocket	Reinstall chain correctly on drive sprocket
	Bar or chain is damaged	Replace chain and/or guide bar
	Sprocket blocked by debris	Remove guide bar and clean sprocket area
	Motor issue (diagnostic test)	Remove bar/chain, reinstall battery, and test. If sprocket spins freely, motor is OK. If not, contact service center
Motor & chain run but cutting is poor	Chain is blunt or worn	Sharpen or replace chain
	Chain is installed backwards	Reinstall chain in correct direction
	Chain is too loose or too tight	Adjust chain tension
	Chain is dry	Fill oil tank and ensure oil is feeding properly

Problems	Possible Causes	Corrective Action
Battery charge indicator does not light	Battery not seated on charger correctly	Remove and reinsert battery on the charger.
	Charger or battery damaged	Replace as needed. Contact Yardcore Support.
Bar and chain are hot or smoking	Chain is too tight	Adjust chain tension
	Oil tank is empty	Refill with bar & chain oil
	Oil port or guide bar is clogged	Remove bar and chain, clean oil port and groove
	Oil cap vent is blocked	Remove and clean oil cap
Chain not lubricating	Debris around sprocket or guide wheels	Clean chain drive area thoroughly
	Oil tank is empty	Refill bar & chain oil
	Oil port is clogged	Clean oil discharge port
Unusual noises or vibration	Oil not flowing due to cold weather	Use low-viscosity oil or warm tool before use
	Loose chain or guide bar	Turn off tool and tighten all components securely
	Worn chain or sprocket	Inspect and replace if needed
Battery not charging	Debris in housing	Remove battery and clean tool thoroughly
	Battery too hot or cold	Allow battery to return to room temperature
	Charger not plugged in	Check power source and connections
	Dirty battery terminals	Clean terminals with dry cloth
	Battery fault	Try with a different battery; if issue persists, contact support

ENVIRONMENTAL NOTE

Yardcore is committed to protecting the environment and reducing unnecessary waste. Please dispose of packaging, batteries, and worn-out tools responsibly.

1. Packaging Materials – Recycle cardboard, plastics, and inserts according to your local recycling guidelines.
2. Batteries – Do not dispose of lithium batteries in household trash. Take them to a certified recycling center or battery drop-off location.
3. Tool Disposal – When your tool reaches the end of its life, dispose of it at an official e-waste facility or recycling program.

For more information, visit www.yardcoretools.com/recycle

WARRANTY INFORMATION

Thank you for choosing Yardcore™. We're committed to delivering high-quality outdoor tools built to perform reliably – season after season – while giving back to the planet.

LIMITED WARRANTY – 2+1 YEARS

Yardcore™ warrants that the tool, battery, and charger, if included with this product, are free from defects in materials and workmanship under normal residential use for a period of **2 years** from the original date of purchase.

When you register your product within **30 days**, Yardcore™ will extend your warranty by 1 additional year, for a total of **3 years** of limited coverage. If a covered defect arises during the warranty period, Yardcore™ will, at its sole discretion, provide one of the following remedies:

- A refund of the original purchase price
- Repair instructions or troubleshooting support
- A replacement, if feasible, through Amazon's platform
- Only one warranty claim is permitted per product.

WHAT'S COVERED

This 2+1-year limited warranty applies to:

- Yardcore™ tools
- Yardcore™ lithium-ion batteries
- Yardcore™ battery chargers

WHAT'S NOT COVERED

This warranty does not cover:

- Normal wear and tear (e.g., chain, guide bar, sprockets, cosmetic wear)
- Damage from misuse, abuse, or neglect
- Commercial or rental use
- Use of non-Yardcore™ accessories or parts
- Damage due to unauthorized repairs or modifications
- Failure to follow the operator's manual instructions

HOW TO OBTAIN WARRANTY SERVICE

All Yardcore™ products are sold exclusively through authorized retailers.

If purchased on Amazon: Warranty service for Amazon orders is handled directly through Amazon's return and messaging system for fast support.

To request warranty assistance:

1. Stop using the product immediately.
2. Log in to your Amazon account and locate your Yardcore™ order.
3. Click "Contact Seller" or "Return/Replace Item."
4. Provide:
5. Your Amazon Order ID
6. A description of the issue
7. Photos or video (if applicable)

If purchased from yardcoretools.com or another authorized dealer: Visit www.yardcoretools.com/warranty for the latest warranty claim instructions and contact details.

NOTICE: Warranty support is only available for items purchased from authorized sellers.

LIMITATION OF LIABILITY

To the extent permitted by law, Yardcore™ shall not be liable for incidental or consequential damages resulting from the use or inability to use this product. This Limited Warranty gives you specific legal rights, and you may also have other rights, which vary from state to state.

NON-TRANSFERABLE WARRANTY

This warranty is valid only for the original purchaser and is non-transferable. Proof of purchase is required for all claims.

PROOF OF PURCHASE REQUIRED

A valid proof of purchase, such as an original receipt, invoice, or Amazon order confirmation, is required for all warranty claims.



PRODUCT REGISTRATION

Register your Yardcore™ product for:

- Faster warranty support
- Safety alerts & recall notices
- Exclusive offers and tool tips
- Early access to new products

To activate your full 3-year limited warranty, please register your product within **30 days** of purchase.

REGISTER NOW

Scan the QR code or visit: register.yardcoretools.com

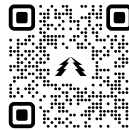

Scan QR CODE for Product Registration and activate the +1 Year extended warranty

YOUR PRIVACY

We'll use your email and phone number (if provided) only for:

- Warranty & product support
- Yardcore™ updates and promotions (with your consent)

NOTICE: Registration is optional but helps us serve you better and is required to unlock your 3rd year of coverage.

WARRANTY VOID CONDITIONS

Your Yardcore™ warranty will be considered void if:

- Used for commercial or rental purposes
- Modified or repaired by unauthorized persons
- Stored improperly or exposed to extreme conditions
- Used outside its intended purpose or design
- False or misleading information is provided in a warranty claim

LEGAL DISCLAIMER

Yardcore™ reserves the right to update product specifications, features, designs, and packaging details at any time, without prior notice, to reflect ongoing improvements or regional requirements. For the latest product updates, manuals, and warranty terms, please visit: www.yardcoretools.com

CONTACT INFORMATION

Please contact us for any information or support needs.

HEADQUARTERS

ZHEJIANG J SHINE IMP & EXP CO., LTD.
Address: No. 27 Wujiang Avenue, Shentang Industrial Zone, Jinhua City, Zhejiang Province, China

MANUFACTURING FACILITY & OFFICE

ZHEJIANG WELLSHINE INDUSTRY & TRADE CO., LTD.
Shentang Industrial Zone, Baiyang Street, Wuyi, Jinhua, Zhejiang, China

CONTACT INFO

EMAIL – SALES@YARDCORETOOLS.COM

EMAIL – SUPPORT@YARDCORETOOLS.COM

SOCIAL MEDIA HANDLES

FACEBOOK – @YARDCORETOOLS
LINKEDIN – @YARDCORETOOLS
INSTAGRAM – @YARDCORETOOLS
YOUTUBE – @YARDCORETOOLS

WEBSITE

WWW.YARDCORETOOLS.COM
WWW.YARDCORE.US

BUYING ON AMAZON

Search: "YardcoreTools" on Amazon

Yardcore reserves the right to update product information, specifications, and packaging details as needed based on ongoing improvements or regional requirements. For the latest product updates, support documents, and warranty terms, please visit our official website: www.yardcoretools.com

1 TOOL = 1 TREE PLANTED 

For every Yardcore tool sold, we give back by planting a tree through our partnership with One Tree Planted. Learn more about our sustainability efforts at: www.yardcoretools.com/sustainability

YARDCORE MISSION

To provide durable, eco-conscious gardening tools and expert knowledge, enabling families to grow with confidence, care for the environment, and create gardens where they can connect and flourish.

YARDCORE PURPOSE

We are driven to create eco-conscious gardening tools that empower families to build gardens they can be proud of, fostering moments of connection while protecting the planet.

YARDCORE VISION

To inspire and support families in creating sustainable, thriving gardens that bring joy, nurture the earth, and cultivate lifelong memories.

THANK YOU FOR CHOOSING YARDCORE

We're proud to support your yardwork with reliable, battery-powered tools.

Your support fuels our mission to build tools that are better for people, and better for the planet.

**REGISTER
YOUR
YARDCORE
TOOL**

**S
C
A
N**

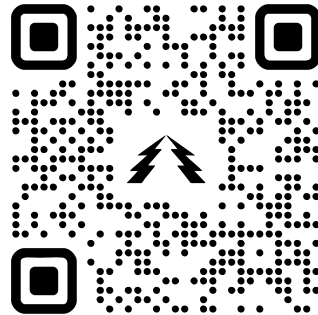

Scan The QR Code Or Visit: register.yardcoretools.com



YARDCORE®
TOOLS BUILT FOR NATURE